



User Guide

1.0 | June 2014 | 3725-65974-001/E

Polycom CX5100 Unified Conference Station



Trademark Information

POLYCOM® and the names and marks associated with Polycom's products are trademarks and/or service marks of Polycom, Inc., and are registered and/or common law marks in the United States and various other countries. All other trademarks are the property of their respective owners.

Patent Information

The accompanying product may be protected by one or more U.S. and foreign patents and/or pending patent applications held by Polycom, Inc.

© 2014 Polycom, Inc. All rights reserved.

Polycom, Inc.
6001 America Center Drive
San Jose CA 95002
USA

No part of this document may be reproduced or transmitted in any form or by any means, electronic or mechanical, for any purpose, without the express written permission of Polycom, Inc. Under the law, reproducing includes translating into another language or format.

As between the parties, Polycom, Inc., retains title to and ownership of all proprietary rights with respect to the software contained within its products. The software is protected by United States copyright laws and international treaty provision. Therefore, you must treat the software like any other copyrighted material (e.g., a book or sound recording).

Every effort has been made to ensure that the information in this manual is accurate. Polycom, Inc., is not responsible for printing or clerical errors. Information in this document is subject to change without notice.

Table of Contents

About This Guide	3
About Conventions Used in this Guide	3
Understand Information Icons	3
Understand Terms Used in this Guide	4
Understand Typographic Conventions	4
Get More Information	4
Find Product Documentation	4
Use the Knowledge Base	5
Contact Technical and Solution Support	5
Get Started	6
Introduce the Polycom CX5100 System	6
About the Polycom CX5100 System	7
Set Up Your System Hardware	8
Connect a Computer to the System	8
Power On and Off	9
Understanding the Indicator Lights	9
First-time Startup	10
Best Practices for Effective Camera Tracking	10
Tips for Setting Up the Room	10
Tips for Meeting Participants	10
Place and Answer Calls	11
Place a Video Call	11
Answer a Call	11
End Calls	12
Control What You Hear	12
Control What the Far End Hears and Sees	12
Customize Your System	13
Use the CX5100/CX5500 Control Panel	13
Find Your Default System Password	13

Create or Load a System Profile	14
Update the CX5100 System's Software	16
Troubleshoot Issues	18
Solve Audio and Video Problems	18
Accessing System Information	20
Testing the System's Speaker, Microphones, and Camera	20
Capturing Logs and Diagnostic Information	20
Restoring the System to Factory Settings	21
Regulatory Information	22

About This Guide

The Polycom CX5100 Unified Conference Station User Guide is intended for anyone who needs to use, customize, and troubleshoot the Polycom CX5100 system. This guide includes overview information that you may find helpful when you're just starting to learn about video conferencing or if you need a quick refresher. It also includes step-by-step instructions for everyday video conferencing tasks.



About Conventions Used in this Guide

To help you find what you want quickly, this guide uses the same information icons, terms, and writing conventions throughout the book. This section describes these conventions.

Understand Information Icons

These icons help you quickly identify information of special interest.

Information Icons Used in this Guide

Type of Icon	Icon	Type of Information
Note		A <i>Note</i> highlights information you need to know to successfully accomplish a procedure or understand a concept.
Caution		A <i>Caution</i> highlights a risk of damage to equipment, loss of data, or impact to security.
Warning		A <i>Warning</i> highlights a risk of injury to a person.

Understand Terms Used in this Guide

Understanding these terms helps you understand the information in this guide more easily.

Terms Used in this Guide

Category	Term	Description
General	active call	Any call (including a conference call) in which you are participating. You can see and hear the other sites in the active call, and they can see and hear you, unless you mute your video or audio.
	held call	Any call (including a conference call) that is on hold. When a call is on hold, you can't see or hear other participants in the call, and they can't see or hear you.
	privacy cap	Physical camera cover for the Polycom CX5100 system cameras.
	system	Refers to the CX5100 Unified Conference Station.

Understand Typographic Conventions

The following table lists the typographic conventions are used in this guide to distinguish different types of information.

Typographic Conventions Used in this Guide

Blue	Used for cross-references to other information in this document and links to external web pages or documents.
<i>Italics</i>	Used to emphasize text, to show example values, and to show titles of reference documents.
Bold	Indicates interface items such as menus, soft keys, file names, directories, and text you need to enter.
Menu > Submenu	Indicates a series of menu choices. For example, Administration > System Information indicates that you should select the Administration menu and then select System Information.

Get More Information

You can find a wide variety of useful information about your system on the Polycom Support site at support.polycom.com.

Find Product Documentation

You can find Polycom product documentation on the [Polycom CX5100](#) support page on [Polycom Support](#).

The following documents are available on the support page:

- [Setting up the Polycom CX5100 and CX5500 Systems](#)

- [Polycom CX5100 Release Notes](#)

Use the Knowledge Base

For more troubleshooting information, search the [Knowledge Base](#) at [Polycom Support](#).

Contact Technical and Solution Support

For support or service, please contact your Polycom distributor or go to [Polycom Support](#).

Get Started

This following sections introduce you to the Polycom CX5100 system: how it works, what it looks like, and how to get started using it to participate in video conferences.

Introduce the Polycom CX5100 System

The Polycom CX5100 unified conference station lets you use the collaboration capabilities of Microsoft Lync voice, video, and content while automatically tracking the flow of conversation to enable richer, more interactive communication. The CX5100 system provides the camera and microphones. You place, answer, and control Microsoft Lync calls using the computer connected to the system.

During a call, the integrated cameras capture the entire panoramic view of your conference room, and the integrated microphones capture the voices coming from any location around the table. During calls, the system automatically shows the person who is speaking, along with a 360-degree view of the other participants in the room. The site with the active speaker sees the last speaker. See the figure below for an example of how the CX5100 system works.

How the CX5100 system works

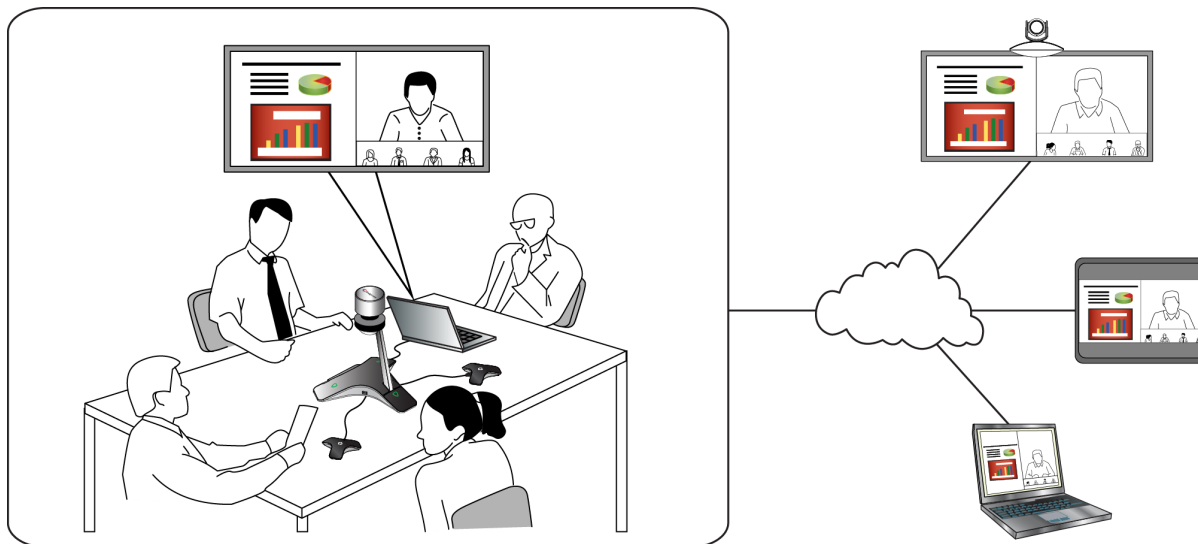

About the Polycom CX5100 System

The following figure introduces you to the parts of the Polycom CX5100 tabletop unit, which houses the camera, microphones, and speakers.

Parts of the Polycom CX5100 Tabletop Unit

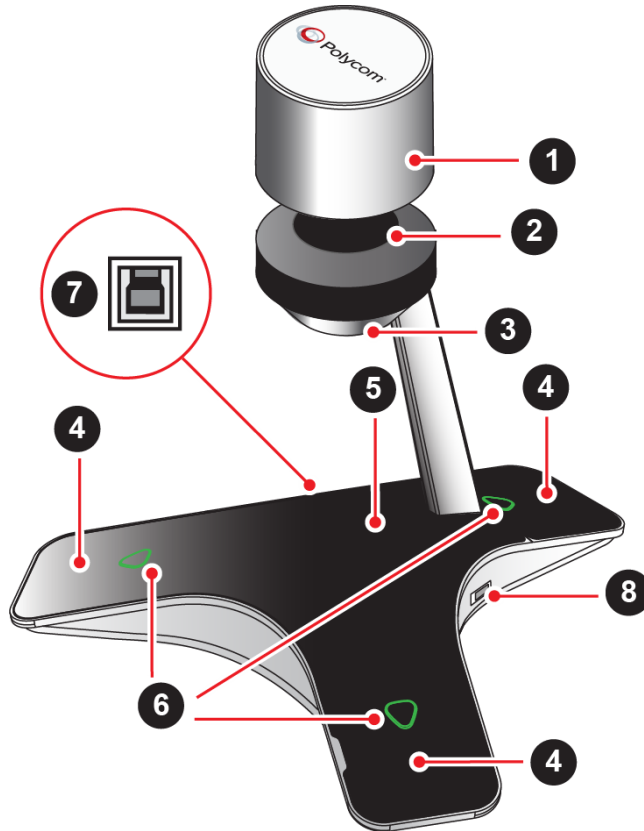

Parts of the CX5100 Tabletop Unit

Feature	Description
1	Camera cover
2	Cameras
3	Active video indicator
4	Microphones
5	Speaker
6	Microphone mute buttons
7	USB 3.0 Type B connection to computer
8	USB 2.0 connector for memory stick

Set Up Your System Hardware

When setting up your CX5100 system, place the system in the center of the conference room table and connect the cables according to the configuration shown in the document [Setting up the Polycom CX5100 or CX5500 System](#), which was shipped in the box with your system. You can also find this guide on the [Polycom CX5100](#) support page on [Polycom Support](#).

For larger conference rooms, you can connect two optional satellite microphones. The following diagram shows how to place the microphones.

Placing the satellite microphones

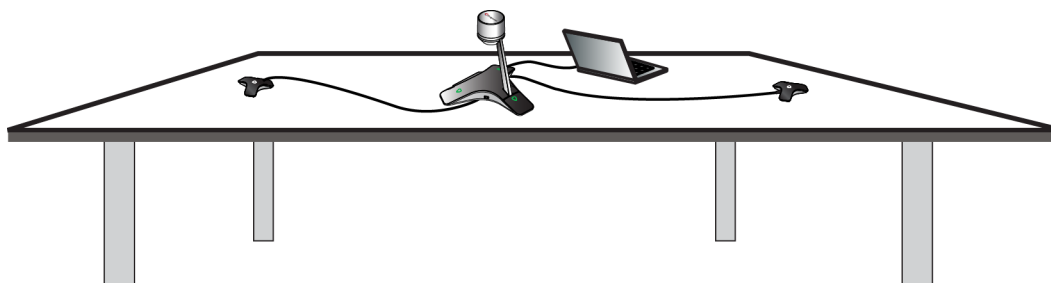

Connect a Computer to the System

System performance may vary based on the connected computer, your network connection, and your Lync client version. The computer connected to the system should meet the minimum hardware and software requirements shown in the following table.

Minimum Hardware and Software Requirements for the Connected Computer

Category	Requirements
Windows	Windows 8.1 (32-bit and 64-bit) Windows 8 (32-bit and 64-bit) Windows 7 (32-bit and 64-bit)
Desktop Client	Microsoft Lync 2013 (recommended) Microsoft Lync 2010
Processor	Basic Video Transmit <ul style="list-style-type: none"> 2.0 GHz or higher HD Transmit <ul style="list-style-type: none"> Quad cores, 2.0 GHz or higher For the Lync 2013 client, find detailed system requirements at Lync Client Software Support on Microsoft Lync TechCenter . For the Lync 2010 client, find detailed system requirements at Client and Device Software and Infrastructure Support on Microsoft Lync TechCenter .
RAM	2 GB
Hard drive space	1.5 GB
Video card	Minimum 128 MB RAM with support for full hardware acceleration

Minimum Hardware and Software Requirements for the Connected Computer

Category	Requirements
Monitor	Minimum 1024 x 768
USB connector	USB 3.0 is required for 1080p calling. Connecting the system to a USB 2.0 or USB 1.0 port may result in reduced performance. If you see a message that your system could run faster when you connect the CX5100, the system is connected by USB 2.0.



Using Third-party USB Extension Cable

If you use a third-party USB extension cable to increase the distance between the tabletop unit and the PC, be aware that most extension cables limit the data rate or provide only USB 2.0 performance, even when plugged into a USB 3.0 port.

When you connect the CX5100 to the PC by USB 2.0, you will see a warning that your system could run faster.

Power On and Off

Connect the power to the Polycom CX5100 system. While the system starts up, the green indicators flash. When the indicator lights stop flashing and the indicators are off, the system is ready to use. You do not need to power the system on or off.

Understanding the Indicator Lights

The Polycom CX5100 system indicator lights let you know whether the system is sending audio or video in video calls. The three microphone indicator lights are located on the tabletop unit base. The active video indicator light is located on the underside of the camera head. See [Parts of the Polycom CX5100 Tabletop Unit](#) for the location of the microphone and active video indicators.

About Microphone Indicator Lights

Microphone Indicator	System State
Off	Not in a call
Green	In call
Green flashing	Ringling
Green slow flashing	System is starting up
Red	In call with microphones muted
Red flashing	Ringling with microphones muted On hold
Green/red flashing	Software update is in progress

About Active Video Indicator Lights

Active Video Indicator	System State
Off	Not in a call No video in a call
Green	In call with active video
Flashing	Privacy cap is closed

First-time Startup

After you connect your system and power it on, the indicator lights flash. When the flashing ends, you can make Lync calls using the computer connected to the system.

Best Practices for Effective Camera Tracking

To ensure that the Polycom CX5100 system can track the active speaker most effectively, follow the guidelines in this section.

Tips for Setting Up the Room

Follow these best practices listed below when setting up your CX5100 system in a conference room.

- Place the device in a large conference room, rather than a small room.
- If the room has hard walls or large windows, consider installing sound-absorbing panels and window blinds or drapes.
- Place the device in the center of the table, and place the table in the center of the room.
- If wall displays are part of the room's setup, move the device closer to the displays.
- Place the device so that participants are speaking toward the device. Avoid placing the device so that participants speak away from the system, especially if they are nearby.

Tips for Meeting Participants

Follow these best practices listed below to ensure that your Polycom CX5500 system effectively tracks active speakers and participants during conference calls.

- Make sure there are no items placed between your mouth and the microphones. For example, move your laptop so that it does not block you when you speak.
- Face the CX5100 system, not the whiteboard or the wall, when you stand at the front of a small conference room to speak. Facing the wall can cause echoes that interfere with the active speaker tracking.
- Avoid standing close to the conference table when speaking. Instead, sit at the table or move away from the table so the camera can clearly track your movements.





Place and Answer Calls

Calling and answering with the Polycom CX5100 system uses the familiar Lync interface. This section describes the steps using Lync 2013, but the steps are similar if you use Lync 2010.

Place a Video Call

You can place calls to people and systems in your organization that are registered to the Directory Service.

To place a video call:

- 1 In Microsoft Lync, do one of the following:
 - Click  and scroll to the contact you want to call.
 - Start typing a name in the search box and click . As you type, the system finds matching names.
 - Click  and choose a name from your Recent Calls.
- 2 Click a name to select it.
- 3 Click  to start a video call.

To invite others to join a conference:

- » From a conversation window in Microsoft Lync, do one of the following:
 - Click  and then click **Invite More People**. Find the person you want and click **OK**.
 - Drag a contact from your contacts list into the conversation window.

Answer a Call

When you receive a call, you see a call notification that tells you who is calling.

To answer a call:

- » In the incoming call notification, do one of the following:
 - Click **Accept** to join the call.
 - Click **Redirect > Reply with an Instant Message** to send a message to the caller.

To refuse a call:

- » In the incoming call notification, do one of the following:
 - Click **Decline**.
 - Click **Ignore** to refuse the call.

End Calls

Hanging up a call with another person automatically disconnects the other person. When you hang up from a conversation that includes multiple participants, the other participants remain connected.

To end a call:

- » In Microsoft Lync, click .

Control What You Hear

During a call, you can control what you hear at the local site.



To adjust the volume:

- » Click  in your Windows tray and use the slider control

Control What the Far End Hears and Sees

During a call, you can control what the far sites can hear and see.

To mute the microphone:

- » On the base of the system, touch . The microphone indicators on the base of the tabletop unit are red when the system is muted: .



You can also mute the system's audio using the Mute button in the Lync client. However, muting the system in this way does not update the indicator lights on the tabletop unit.

To mute the video:

- » Lower the privacy cap on the tabletop unit. The active video indicator flashes green to indicate that the system is not sending video to the far end.

Customize Your System

You can use the Polycom CX5100/CX5500 Control Panel to customize your Polycom CX5100 system.

Use the CX5100/CX5500 Control Panel

You can configure your CX5100 system using the CX5100/CX5500 Control Panel application running on the computer connected to your system.

To install the CX5100/CX5500 Control Panel:

- 1 Using a web browser, go to the [Polycom CX5100](#) support page.
- 2 Download the Control Panel installation file to the computer connected to the CX5100 system.
- 3 Double-click the installation file and follow the prompts to install the application.

After you install the Control Panel, you can connect your system to your computer and create a profile for CX5100 system, view your system's information, change system settings, and view diagnostics and retrieve logs.

Find Your Default System Password

In order to make changes to you Polycom CX5100 system using the Control Panel, you need to enter the system password. By default, the password is the 14-digit system serial number. You can find the serial number on the label on the back panel of the power data box, as shown in the following figure.

Location of the Serial Number Label on the Power Data Box



After you enter the default password, you can change the system's password in the System tab in the Control Panel.

To change the system default password:

- 1 In the Control Panel, click **System > Password**.
- 2 Enter the default password in the **Old Password** field.

- 3 Enter a new password for the system in the **New Password** field and retype the new password in the **Confirm New Password** field.
- 4 Click **Change Password**.
Your new password is saved for the system and you can enter your new password when you need to make changes to your CX5100 system.

Create or Load a System Profile

The Profile Editor in the Control Panel enables you to change device settings and update software. You can also save profiles onto your computer and load a profile to your CX5100 system.

The table [Network Configuration Settings](#) shows the network settings you can configure in the Profile Editor and save onto your CX5100 system.

Network Configuration Settings

Setting	Description
Device Name	Displays the Device Name on the Diagnostics page. Naming your CX5100 helps you manage multiple devices.
Enable Ethernet	Enables the system to connect to the network by Ethernet. You must enable Ethernet before you can configure the system for automatic software updates.
Enable DHCP	Enables the system to use Dynamic Host Configuration Protocol (DHCP) to obtain the IP Address, Default Gateway, Subnet Mask, and Preferred and Alternate DNS Server settings automatically.
Enable EAP/802.1x	Enables the System to use 802.1X authentication. You must Enter the Host Name, Domain Name, EAP Identity, and the EAP passwords manually.

To create a profile:

- 1 Power on the Polycom CX5100 system and connect the Polycom CX5100 system to the computer using the USB cable.

- 2 On your computer, start the **CX5100/CX5500 Control Panel** application.

The Control Panel opens and your device's system information displays in the System tab, as shown in the next figure.

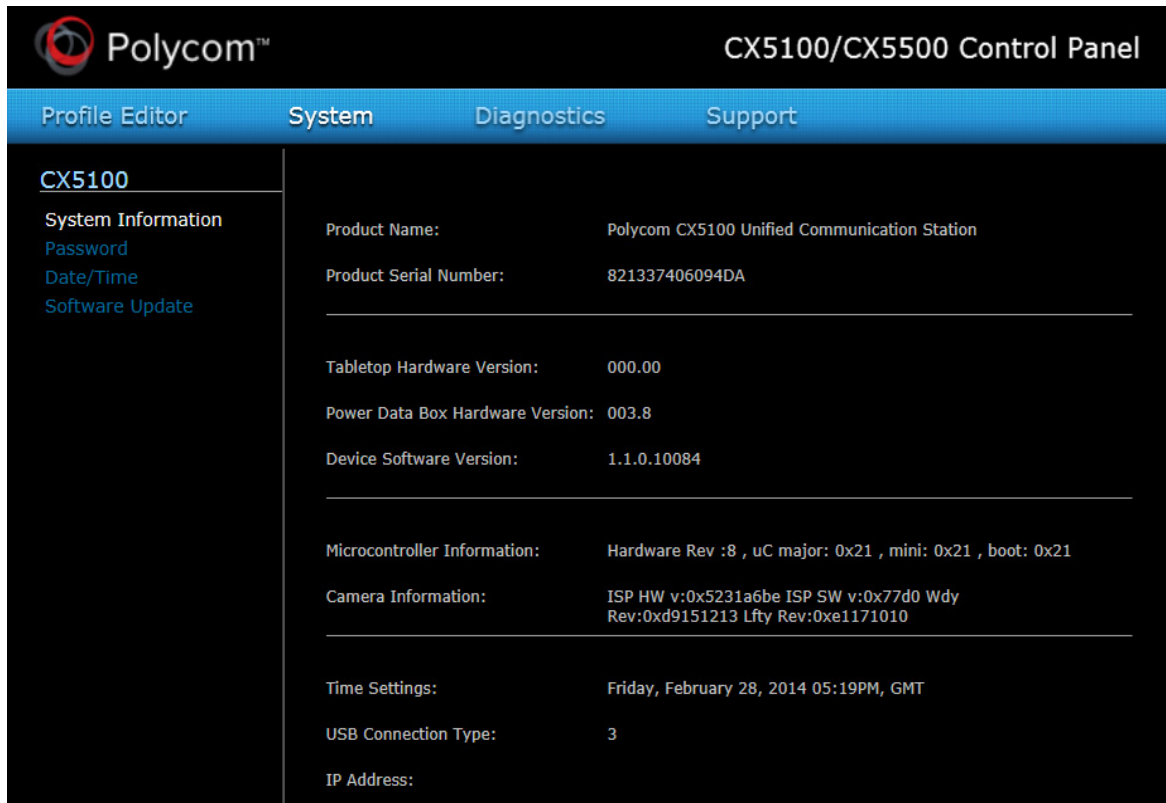

- 3 In the Control Panel, click **Profile Editor**.

The Enter Device Password dialog displays.

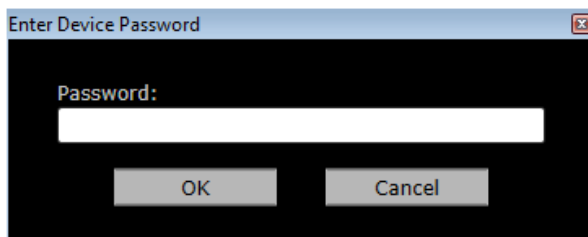

- 4 Enter the Device **Password** and click **OK**.

Note that the default device password is the system's serial number (see figure [Location of the Serial Number Label on the Power Data Box](#) for the location of the system's serial number).

- 5 On the **Network** tab, enter a **Device Name**, select to **Enable Ethernet**, and choose to **Enable DHCP** or **Enable EAP 802.1x**.

Contact your system administrator before changing the network settings for your CX5100 system.

- 6 On the **Time** tab, select your time zone.

You can also choose to enable a time server and enter the NTP Server Address.

- 7 On the **Software Update** tab, enter the name of the **Update Server** and select values for the **Update Frequency** and **Update Time**.
- 8 On the **Advanced** tab, choose the **Mute Button Function**. Select **Microphone only** to mute the audio only or select **Microphone and Camera** to mute the audio and video when you touch the Mute button.

On the Advanced tab, you can also select the power frequency for your system. Contact your system administrator before changing the power frequency settings for your CX5100 system.

- 9 Do one of the following:
 - Click **Apply to Device** to save the profile on your CX5100 system. Enter the system password, if prompted.
 - Click **Save to File (PC)** to save the profile to your computer. Specify the name of the file and the location of where to save the profile and click **Save**.

You can also load a profile from the device, a saved profile from your computer, or a default system profile onto your CX5100 systems.

To load a profile:

- 1 In the **Profile Editor** tab, click **Load Profile**.
- 2 Select one of the following options:
 - **Load from Device** uploads the profile saved on the CX5100 system.
 - **Load from File (PC)** uploads a profile saved on your computer on to the CX5100 system.
 - **Load Default Profile** uploads the factory default profile for the CX5100 device.
- 3 After you make your selection, click **Apply to Device**.

The profile is saved onto the CX5100 system.

Update the CX5100 System's Software

You can configure your system to check for available updates automatically, or you can update the software for your CX5100 system manually in the Control Panel or upload new software to the system using a USB flash drive.

To update the software automatically:

- 1 In the **Profile Editor** tab, select **Software Update**.
- 2 Enter the name of the **Update Server**.
- 3 Select the how often your system updates for **Update Frequency**.
- 4 Select what time your system updates for **Update Time**.

Your CX5100 system retrieves software updates from the server on the chosen date and time, if available.

To update the software manually:

- 1 Click **System > Software Update**.
- 2 Click **Update Now** to start the update.

The system uploads the software update from the server, if available.

To update the software using a USB flash drive:

- 1 Obtain the software update package from your network administrator, and copy the software to a USB flash drive formatted as FAT32. Make sure that there is only one software update package on the flash drive.
- 2 Connect the drive to the USB 2.0 port on the tabletop unit or to the USB 3.0 port on the power data box, as shown in the following figure. The system detects the drive automatically and starts the update within 30 seconds.

Location of the USB 2.0 connectors

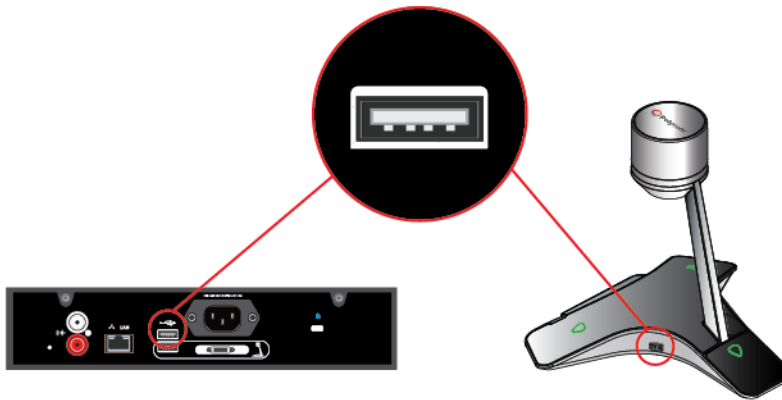

Important Notes About Installation

- The indicator lights begin to flash indicating that the update has started. The system reboots several times during the update, and the indicator lights flash in several different patterns.
- The update can take up to 40 minutes to complete. During this time, the system reboots several times. Make sure that you do not power the system off during an update. Wait for at least 40 minutes to make sure the update has completed.
- The update is complete when the indicator lights stop flashing for at least 30 seconds.

Troubleshoot Issues

If you experience problems using the Polycom CX5100 system, try the following suggestions.



Solve Audio and Video Problems

Use the following table to find possible corrective actions if you experience problems.

Troubleshooting Audio and Video Problems

Symptom	Corrective Action
General	
The system won't power on.	Ensure that your power cable is connected securely to a working power outlet.
The CX5100 Control Panel does not connect to the CX5100 system.	Try the following solutions: <ul style="list-style-type: none">• Disconnect the USB cable from the computer and reconnect it.• Restart the Control Panel application.
Softupdate fails because the system is unable to locate the update software.	Try the following solutions: <ul style="list-style-type: none">• Ensure that your Ethernet cable is connected securely.• Ensure that your Ethernet connection is enabled and configured correctly.• Ensure that the URL of the update server is configured correctly. Click Apply to Device to transfer the settings to the device.• If you continue to have problems, copy the update software to a USB thumb drive, and attach it to the tabletop unit or the power data box. Ensure that there is only one software update package on the USB drive.
My computer is connected to a USB 3.0 port, but I see a warning that my computer is connected to a USB 2.0 port.	Try the following solutions: <ul style="list-style-type: none">• Ensure the system is connected to a USB 3.0 port. A USB 3.0 port is usually blue and has a SS icon next to the port.• Disconnect the USB cable from the computer and reconnect it.• Update the USB 3.0 driver on the computer to ensure that the date of the driver is 2013 or later. Visit your computer's manufacturer's website for the latest driver available for your computer.• Connect the computer directly to the blue USB 3.0 port on the power data box instead of the tabletop unit.
Video	

Troubleshooting Audio and Video Problems

Symptom	Corrective Action
My camera is not listed in the device selection list.	<p>Try the following solutions:</p> <ul style="list-style-type: none"> • Ensure that your camera cable is connected securely. • Verify your video device settings. In Microsoft Lync, click  ▾ Options and choose Video Device. Ensure that CX5100 is selected as the video device. • Restart the Polycom CX5100 system.
Others don't see my video.	<p>Try the following solutions:</p> <ul style="list-style-type: none"> • Ensure that your privacy cap is raised. • Ensure that all cables are connected securely. • Verify your video device settings. In Microsoft Lync, click  ▾ Options and choose Video Device. Ensure that CX5100 is selected as the video device. • Restart the Polycom CX5100 system.
My video is flickering.	<p>Ensure that the Power Frequency is set correctly for your locale. From the CX5100 - CX5500 Control Panel, click System and then click Advanced. Then, choose the Power Frequency you need.</p>
My video is displayed at a very low frame rate.	<p>Try the following solutions:</p> <ul style="list-style-type: none"> • Ensure the system is connected to a USB 3.0 port. A USB 3.0 port is usually blue and has a SS icon next to the port. • Ensure that the tabletop unit is plugged in to the blue USB 3.0 port on the power data box.
Audio	
Others don't hear my audio.	<p>Try the following solutions:</p> <ul style="list-style-type: none"> • Ensure that your audio is not muted using the mute buttons on the tabletop unit or by using the mute button in the Lync client. • Ensure that your microphone cable is connected securely. • Verify your audio settings. In Microsoft Lync, click  ▾ Options and choose Audio Device. Ensure that CX5100 is selected as the audio device.
I don't hear audio from others.	<p>Try the following solutions:</p> <ul style="list-style-type: none"> • Ensure that the far-site audio is not muted. • Ensure that your volume is set to an audible level.
I muted my audio in Lync, but the microphone indicators on the tabletop unit do not show red.	<p>Muting your audio in Lync does not control the CX5100 system's microphone indicators. Your audio is still muted, and the far end does not hear your audio.</p> <p>Update your Lync client to the latest version in order to have the capability of syncing call activity in Lync with your system.</p>

Accessing System Information

The System Info page lets you view a listing of system settings and status that may be helpful in troubleshooting. The information is refreshed each time you access the page. To refresh the page, go to another page and return to the System Info page.



To access information about your system:

- » From the CX5100 - CX5500 Control Panel, click **System** and then click **System Information**.

Testing the System's Speaker, Microphones, and Camera

You can ensure that your Polycom CX5100 is configured and operating correctly by testing the speaker, microphones, and camera.

To test the speaker and microphones:

- 1 From the Microsoft Lync client, click  **Options**.
- 2 Click **Audio Device** and then choose the CX 5100 device as the Audio Device.
- 3 In the Speaker section, click  **Play** to play a tone.
- 4 Adjust the slider to make the tone louder or softer.
- 5 Gently brush your finger over the microphone on the base of the tabletop unit and check to be sure the indicator in the Microphone section turns green in response. If there is no response, check to be sure the microphone is not muted.
- 6 Adjust the slider to make the microphone more or less sensitive.

To test the camera:

- 1 From the Microsoft Lync client, click  **Options**.
- 2 Click **Video Device** and check the video preview.

Capturing Logs and Diagnostic Information

If you contact Polycom for help with a system problem, you might be requested to supply information about your system.

To retrieve system logs:

- » Connect a USB thumb drive to the USB port on the tabletop unit or on the power data box. Make sure there is no softupdate package on the thumb drive. The logs are transferred automatically. Note that it takes approximately one minute to complete the transfer.



Retrieving logs using the CX5100 - CX5500 Control Panel

You can also use the CX5100 - CX5500 Control Panel retrieve logs to a thumb drive connected to the device.

- 1 From the CX5100 - CX5500 Control Panel, click **System** and then click **Debugging**.
- 2 Connect a USB thumb drive to the USB port on the tabletop unit. Make sure there is no softupdate package on the thumb drive.
- 3 Click **Retrieve Logs** to copy the logs to the thumb drive. Note that it takes approximately one minute to complete the transfer.

To view diagnostics information:

- » From the CX5100 - CX5500 Control Panel, click **Diagnostics**. You can scroll through this information using your mouse. Right-click to copy this information to the clipboard.

Restoring the System to Factory Settings

If you experience severe system problems, you can perform a factory restore. The restore button is on the back of the power data box, as shown in the following figure:

Location of the system restore button

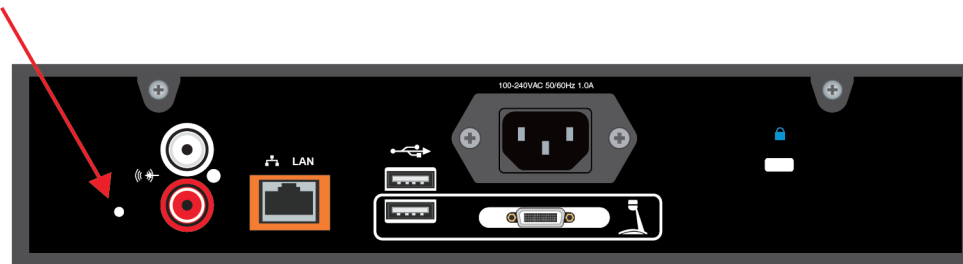

To reset the system to its original factory settings using the restore button:

- 1 While the system is powered off, use a paper clip to press and hold the restore button.
- 2 While holding the restore button, power the system on.
- 3 Keep holding the restore button for 20 more seconds; then release it.

Regulatory Information

Important Safeguards

Read and understand the following instructions before using the system:

- Always disconnect the system from power before cleaning and servicing and when not in use.
- Keep ventilation openings free of any obstructions.
- The power cord acts as the disconnect device. Disconnect power cord to electrically isolate the system, and before removing any covers.
- No user serviceable parts are contained within the device, a qualified technician must perform service or repair work.

Special Safety Instructions



Plug Acts as Disconnect Device: The socket outlet to which this apparatus is connected must be installed near the equipment and must always be readily accessible.

Follow existing safety instructions and observe all safeguards as directed.

Regulatory Notices

Class B Digital Device or Peripheral

This equipment has been tested and found to comply with the limits for a Class B digital device, pursuant to part 15 of the FCC Rules. These limits are designed to provide reasonable protection against harmful interference in a residential installation.

This equipment generates, uses and can radiate radio frequency energy and, if not installed and used in accordance with the instructions, may cause harmful interference to radio communications. However, there is no guarantee that interference will not occur in a particular installation. If this equipment does cause harmful interference to radio or television reception, which can be determined by turning the equipment off and on, the user is encouraged to try to correct the interference by one or more of the following measures:

- Reorient or relocate the receiving antenna.
- Increase the separation between the equipment and receiver.
- Connect the equipment into an outlet on a circuit different from that to which the receiver is connected.
- Consult the dealer or an experienced radio/TV technician for help.

Part 15 FCC Rules

This device complies with part 15 of the FCC rules. Operation is subject to the following two conditions:

- 1) This device may not cause harmful interference, and
- 2) this device must accept any interference received, including interference that may cause undesired operation.

Industry Canada (IC)

This Class [B] digital apparatus complies with Canadian ICES-003.

Cet appareil numérique de la Classe [B] est conforme à la norme NMB-003 du Canada.

Regulatory Notices

Europe

This Polycom CX5100 has been marked with the CE mark. This mark indicates compliance with EEC directories 2006/95/EC and 2004/108/EC. A full copy of the Declaration of Conformity can be obtained from Polycom Ltd., 270 Bath Road, Slough, Berkshire, SL1 4DX, UK.

Singapore

Complies with

IDA Standards

DA101619

Class B Statements

Japan

この装置は、クラスB情報技術装置です。この装置は、家庭環境で使用することを目的としていますが、この装置がラジオやテレビジョン受信機に近接して使用されると、受信障害を引き起こすことがあります。
取扱説明書に従って正しい取り扱いをして下さい。 VCCI-B

Korea

B급 기기 (가정용 방송통신기기): 이 기기는 가정용(B급)으로 전자파적합등록을 한 기기로서 주로 가정에서 사용하는 것을 목적으로 하며, 모든 지역에서 사용할 수 있습니다.